

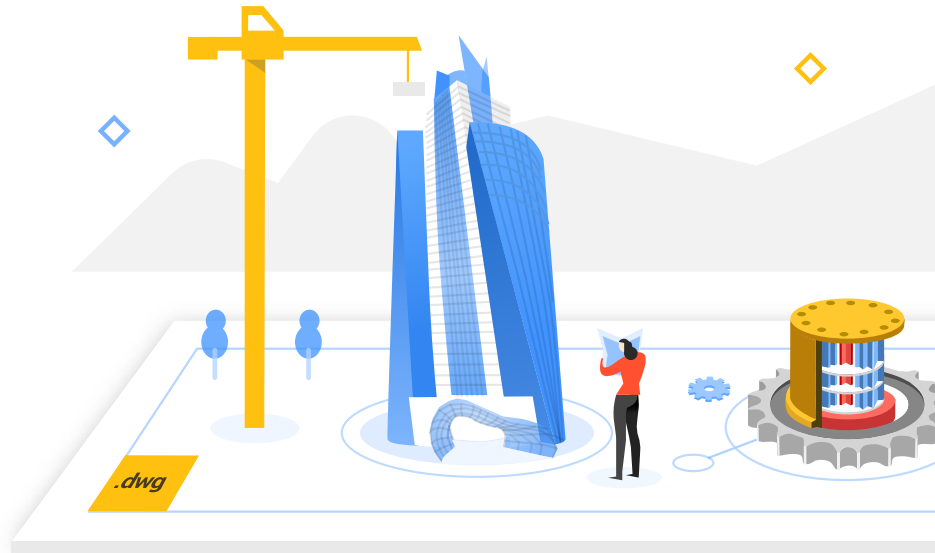

# BricsCAD®. One workflow to design tomorrow.

BricsCAD is the familiar design platform for all your needs; 2D drafting, 3D modeling, Mechanical design and BIM.



## 2D/3D CAD Design Toolkit

A faster and smarter way to create 2D or 3D CAD designs with a familiar CAD platform, all in .dwg.



## Concept Design

Let your imagination run free in BricsCAD Shape, with full CAD accuracy at all times.



## Building Information Modeling

Capture your ideas with BricsCAD BIM and move straight to documentation, in a familiar workflow.



## Project Management

Collaborate securely. Revise accurately and smoothly. Automate repetitive tasks.



## Product Design & Manufacturing

Get the best tools to support the changing mechanical world. Making things faster and better, for less.



## Third Party Applications

Solutions for AEC, GIS, Scaffolding, Electrical, etc. The sky is the limit.

## Switch to a better .dwg platform

BricsCAD® is the design platform that everyone wants.

One file format - .dwg - with compatibility that feels amazingly familiar.

And, a workflow approach that favors your past, or the future.

All at your command.

- ✓ Familiar 2D & 3D Interface
- ✓ Native .dwg 2018 file format
- ✓ Rich application catalogue
- ✓ Perpetual licenses available

Learn more at [www.bricsys.com](http://www.bricsys.com)

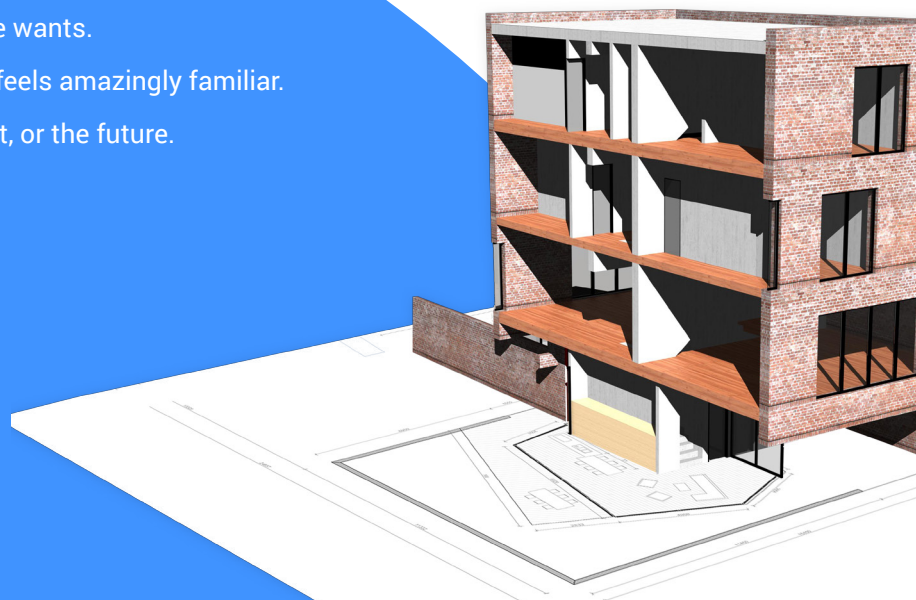

BricsCAD®

# The CAD platform built for tomorrow

Drive modern design workflows with BricsCAD, all in industry-standard .dwg. Use skills you already have to design faster in 2D or 3D.



Familiar CAD Toolkit



2D Drafting, Drawing and Annotation



3D Modeling and Visualization



Cloud Collaboration



Third Party Applications



Highly Customizable Interface

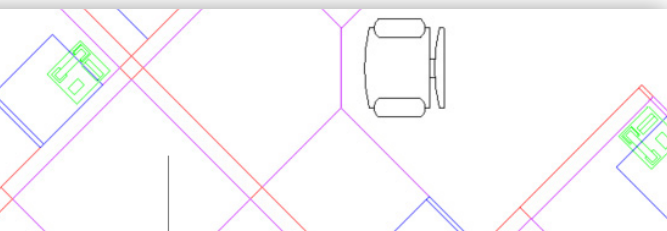

## Blockify

Blockify finds repetitive geometry and automatically creates blocks to reduce .dwg size. It works for both 2D and 3D geometry.

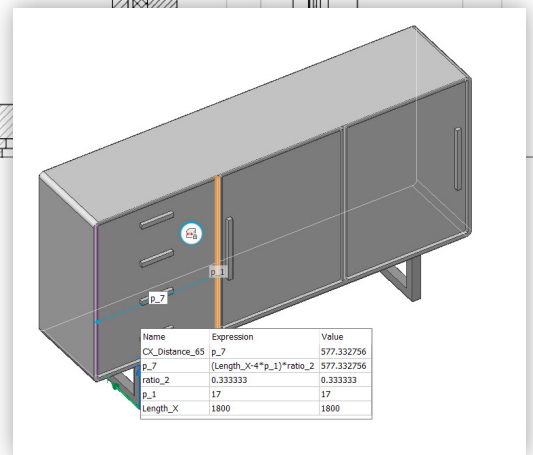
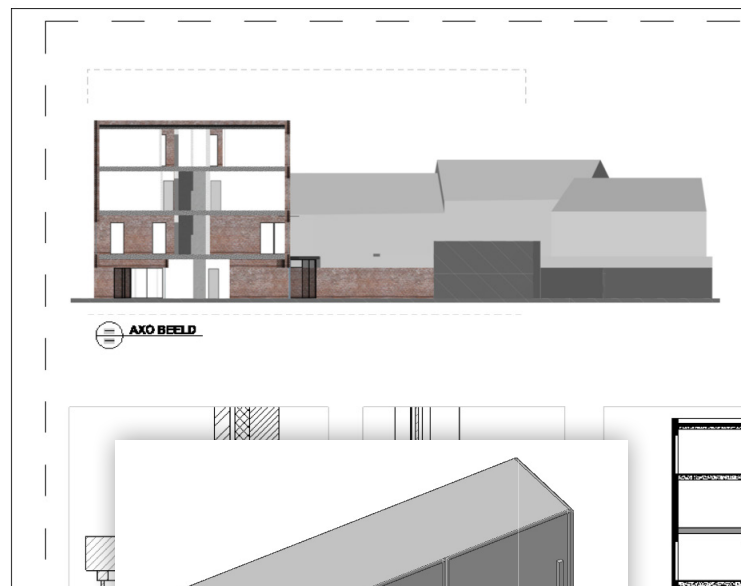
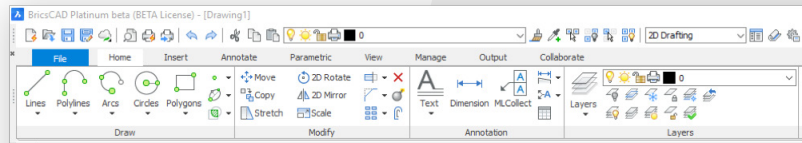
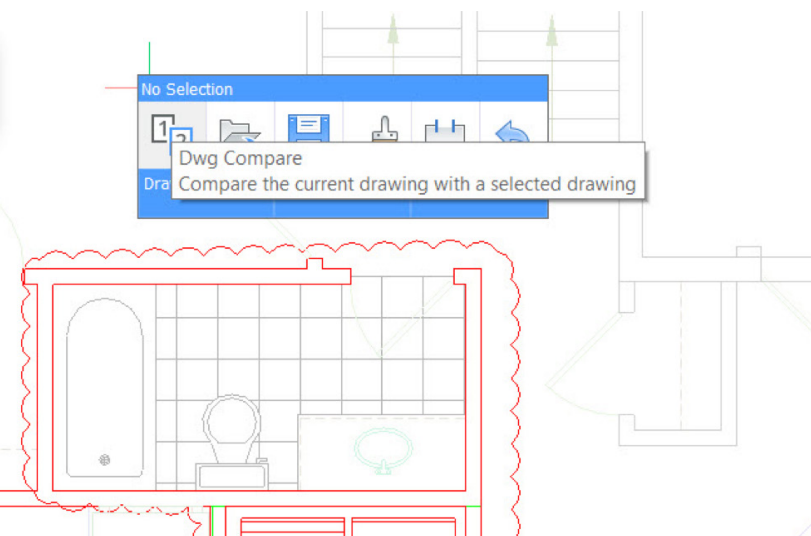

## Auto-constraint parametric components

The parametric design capabilities of BricsCAD are simplified through new ways of displaying constraints.

## Lightning-fast drawing compare

Our repository-based system enables instantaneous drawing comparisons using the unique visual merge feature. Scan any two versions of a drawing, and see all their differences effortlessly.

BricsCAD® BIM

# Real BIM, in .dwg

Go from concept to detailed construction documents in one 3D workflow.



Conceptual Design Tools



Construction Documents



Structural Tools



HVAC Modeling Tools



Design Assistance



IFC Interoperability



Attach Building Data



Project Collaboration

## BricsCAD: The one-stop BIM solution

Create and manage building designs - from concept to construction documentation - in one familiar environment. With BricsCAD BIM, you can use your current CAD skills to smoothly move to creating real Building Information Models in record time. One product, one workflow, all in industry-standard .dwg.

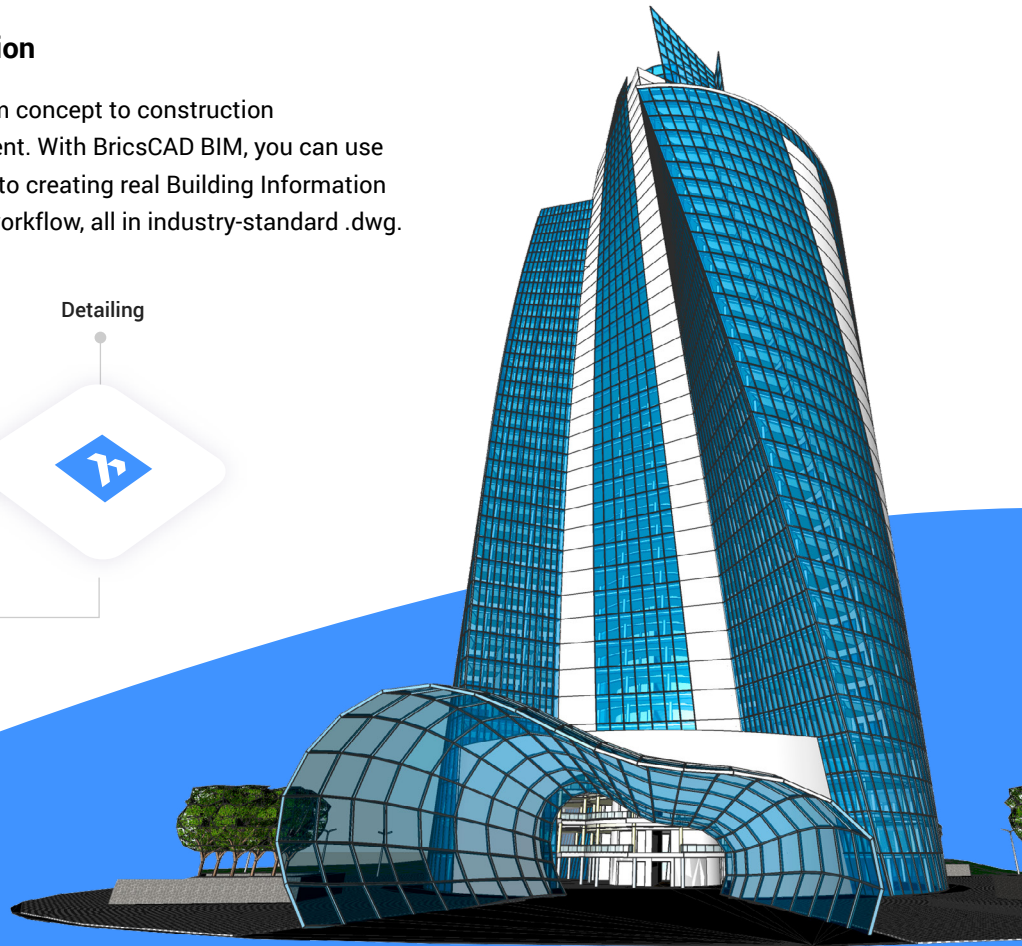
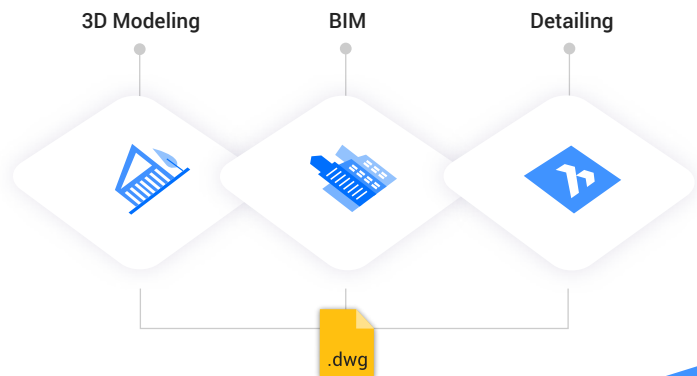

## Ground-breaking tools using the power of AI

Turn your design concept into a full BIM with one click

Run BIMify and building elements are automatically classified, leaving you more time to do what you do best - design.



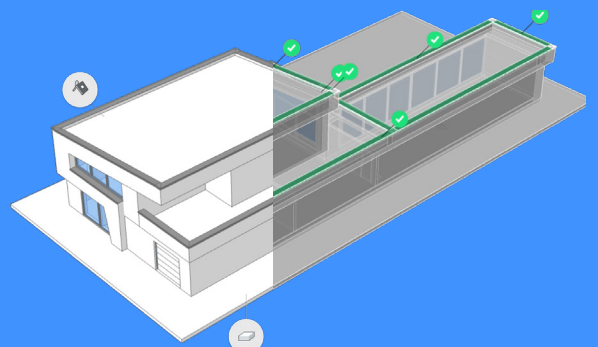

Model it once, use it many times

The Propagate tool uses AI to help you automatically replicate details throughout your BIM.



# Advanced Mechanical design

A complete mechanical design toolkit, all in .dwg. Assemble freely using the power of 3D Direct Modeling.

-  **Model Freely**
-  **Design Efficiently**
-  **Use Any Data**
-  **Automated Drafting**

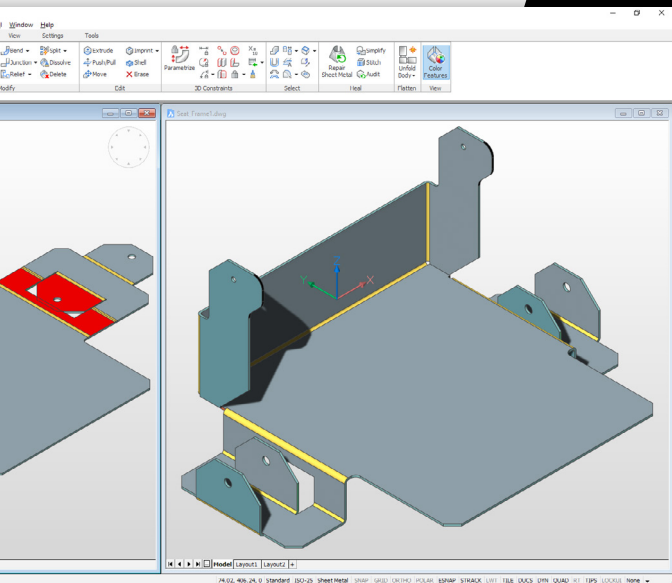
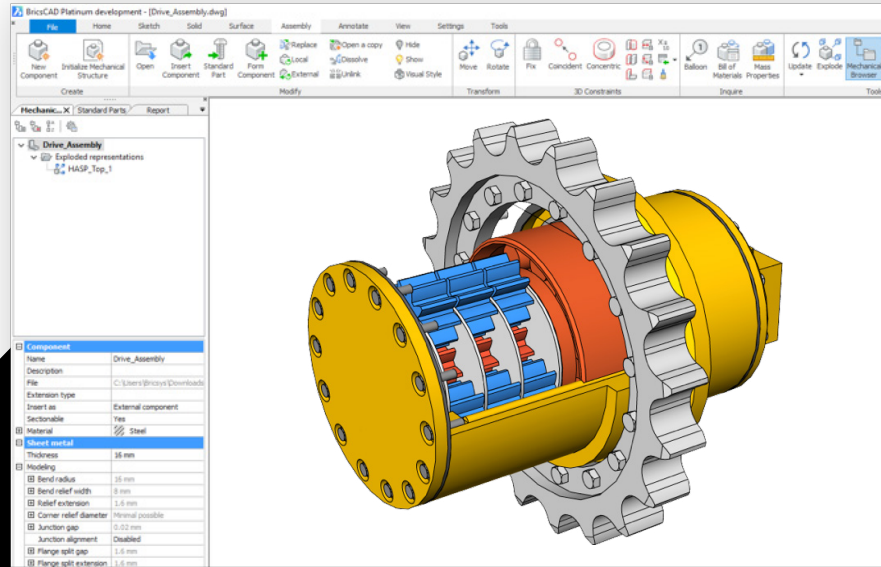

**Import or create from scratch**



**Automatically unfold**



**Rework at any time**



**Export to CAM systems**

## Create sheet metal part designs that are resilient

BricsCAD is free of the conceptual errors that plague history-based MCAD modeling systems. Your designs can be modified without the worry of failure, because we combine the freedom of direct modeling with the power of feature-based design.

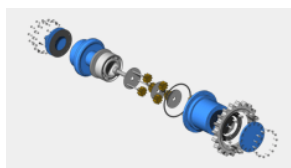

**Automatic exploded representation of assemblies**  
Assemblies can be automatically exploded in multiple ways. Exploded representations are created based on disassembly without collision.

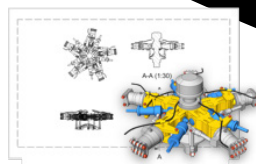

**Automatic Drawing View Creation**  
Automatically generate associative orthographic and standard isometric views of 3D solid models.





Qty	Part	Quantity
1	BRND-05-02-100	4
2	ISO 1055-FLx1 5 x 10-10	4
3	ISO 2008-06 x 10-10	8
4	ISO 4014-M10 x 1.25-100	2
5	ISO 4014-M10 x 2-100	8
6	ISO 4014-M10 x 1.25-20	2
7	ISO 4014-M10 x 2	8
8	NI-AA-005-01-ank_2	1
9	NI-AA-010-01-ank_1	1
10	NI-006-000-01-ank_4	4
11	NI-005-005-01-ank_1	1
12	NI-005-005-01-ank_1	1
13	NI-006-000-01-ank_1	1
14	NI-006-000-01-ank_2	2

**BOM Generation**  
Generate an associative Bill of Material automatically, and place it anywhere in your drawing.

Bricsys® 24/7

# Easy project collaboration

Share, annotate and collaborate on building projects in a common data environment.

-  **Manage your documents globally**
-  **Your perfect model manager for BIM**
-  **Create unlimited users and roles**
-  **Automate repetitive tasks**

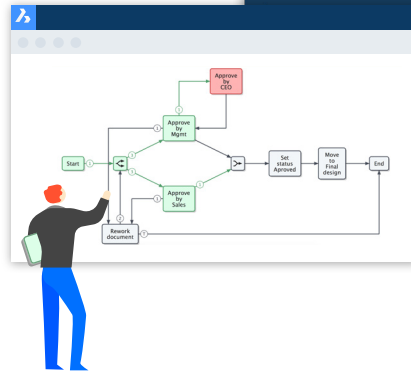
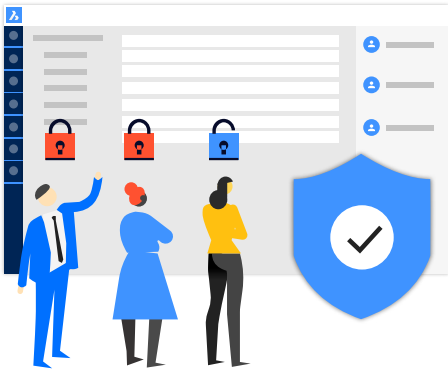
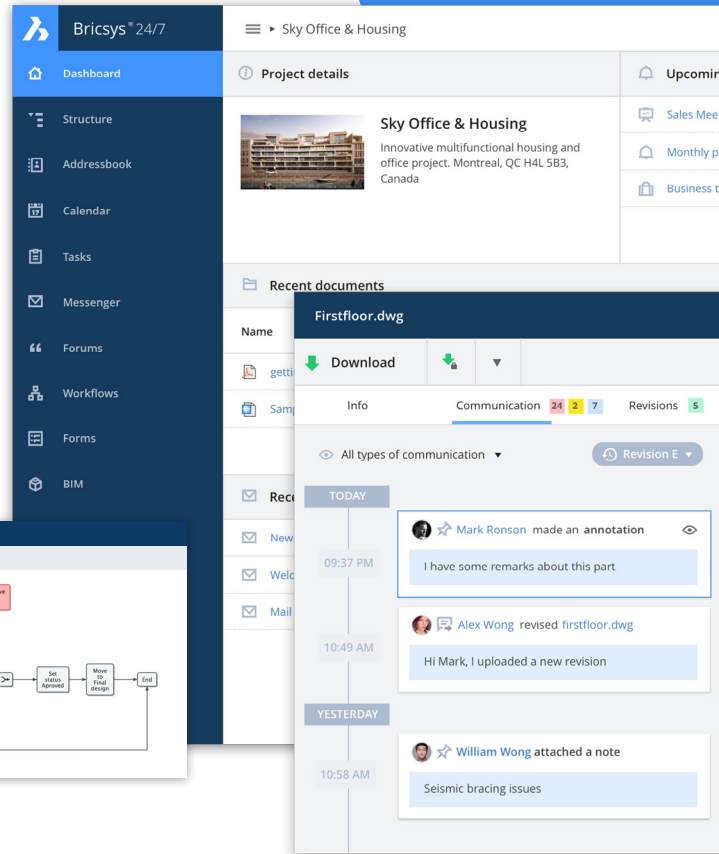

## Create unlimited users and roles

24/7 allows unlimited users to work together. Project administrators can set user rights by creating roles to simplify permissions management. Administration is as easy as 1, 2, 3.

## Automate repetitive tasks

Build your own widgets to automate tasks that you use every day. It's easy with 24/7's drag-and-drop graphical workflow editor.

## Your perfect model manager

Bricsys 24/7 lets you easily share Building Information Modeling (BIM) designs with engineers, construction professionals, building owners and operators. They can explore, view, annotate and slice your 3D models interactively, in the cloud.

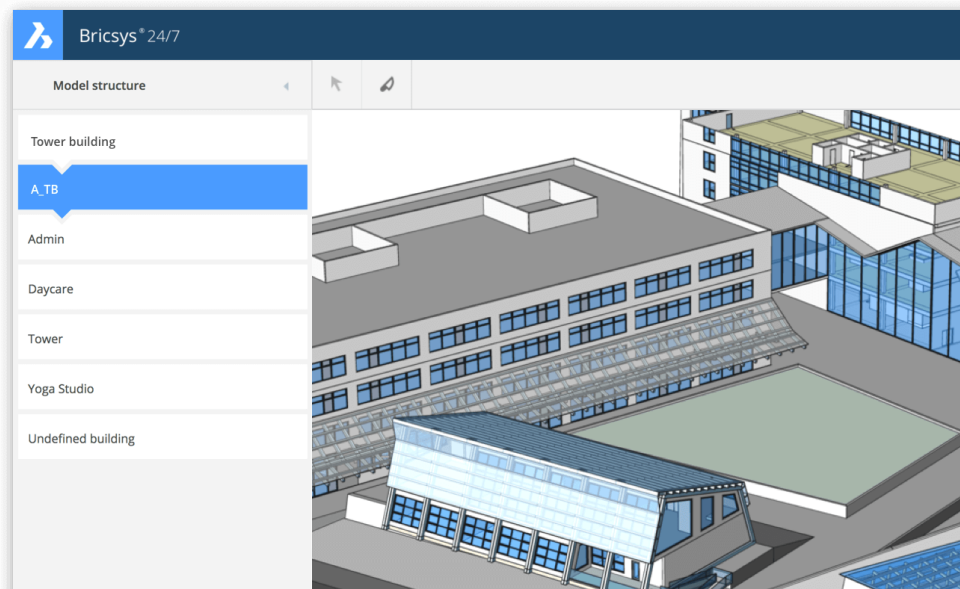

## Our products

# Buy BricsCAD® once, own it forever or subscribe each year. It's your choice.

### BricsCAD® Classic

#### Features including

- ✓ Familiar 2D/3D CAD with more
- ✓ Full LISP customization built-in
- ✓ 100% Real .dwg performance

### BricsCAD® Platinum

#### All BricsCAD Pro features plus

- ✓ 3D Constraints for solids, surfaces, blocks and XREFs.
- ✓ Automatic parametrization of 3D solids
- ✓ Design intent recognition
- ✓ Parametric components and arrays
- ✓ Deformable 3D modeling
- ✓ Graphical 3D model comparison tool

### BricsCAD® Pro

#### All BricsCAD Classic features plus

- ✓ Direct 3D Modeling
- ✓ Rendering with materials & lighting
- ✓ Access to Third Party Applications

### BricsCAD® BIM

- ✓ Real BIM, all in .dwg
- ✓ Free-form 3D Conceptual Modeling
- ✓ Advanced rendering & visualization
- ✓ Automatic classification tools
- ✓ A.I.-based Propagate workflow
- ✓ HVAC & Structural Modeling tools
- ✓ Stunningly accurate take-offs
- ✓ Full IFC Interoperability
- ✓ The world's best documentation tools

### BricsCAD® Mechanical

- ✓ Part & Assembly Design
- ✓ Design intent recognition
- ✓ Assembly constraints
- ✓ Parametric Components
- ✓ Bill-of-Materials generation
- ✓ Sheet Metal Design
- ✓ Kinematic analysis
- ✓ Powerful Drawing Generation
- ✓ Automatic BOM Balloons
- ✓ World's best 2D detailing tools

### Communicator for BricsCAD®

High-quality 3D data exchange between major MCAD formats.

BricsCAD Communicator runs on BricsCAD Pro, Platinum, BIM or Mechanical.

In the last two decades, our singular focus has been building cost-effective, mission critical CAD tools. Built on industry-standard .dwg, our products enable users, CAD managers and applications software developers to achieve their goals in less time, for less money. We get up each morning to focus on these goals.

Learn more at [www.bricsys.com](http://www.bricsys.com)

## BRISYS

HQ European office  
Bellevue 5/201  
B - 9050 GENT  
Belgium  
[contact.eu@bricsys.com](mailto:contact.eu@bricsys.com)